

USER MANUAL

EASYMATE *Liquid Oxygen System*

PM2200 SERIES



SAVE THESE INSTRUCTIONS

CAUTION

Federal (USA) law restricts this device to sale by or on the order of a physician.

PRECISION MEDICAL

Precision Medical, Inc.
300 Held Drive
Northampton, PA 18067 USA

Tel: (+001) 610-262-6090
Fax: (+001) 610-262-6080

CONTENTS

RECEIVING INSPECTION.....	1
SAFETY SYMBOL DESCRIPTION	2
INTENDED USE	3
SPECIFICATIONS	3
WARNINGS & CAUTIONS	4
PRINCIPLES OF OPERATION	6
PORTABLE SYSTEM DESCRIPTION.....	6
OPERATING INSTRUCTIONS.....	6
• FILLING THE PORTABLE	7
• CHECKING THE APPROXIMATE AMOUNT OF LIQUID OXYGEN REMAINING.....	10
• BREATHING FROM THE PORTABLE SYSTEM	10
• POSITIONING	12
• USING THE CARRY BAG	12
CLEANING	13
REPLACEMENT PARTS	13
MAINTENANCE.....	13
RETURNS.....	13
TROUBLESHOOTING.....	14
DISPOSAL.....	15
NOTES	16
WARRANTY.....	17
DECLARATION OF CONFORMITY	18

RECEIVING INSPECTION

Remove product from package and inspect for damage. If there is any damage, do not use and contact your Equipment Provider.

READ ALL INSTRUCTIONS BEFORE USING

Read and understand this manual before using the device. This manual is provided for your safety and to prevent damage to the device. **If there is anything you do not understand**, do not use and contact your Equipment Provider.

SAFETY SYMBOL DESCRIPTION

⚠ DANGER

DANGER indicates an imminently hazardous situation which, if not avoided, will result in death or serious injury.

⚠ WARNING

WARNING indicates a potentially hazardous situation which, if not avoided, could result in death or serious injury.

⚠ CAUTION

CAUTION indicates a potentially hazardous situation which, if not avoided, may result in minor or moderate injury.

CAUTION

CAUTION used without the safety alert symbol, indicates a potentially hazardous situation which, if not avoided, could result in property damage.



Safety Alert Symbol used alone indicates Attention, consult ACCOMPANYING DOCUMENTS.



Symbol for "NO SMOKING"



Symbol for "COVERING DEVICE WITH GARMENTS WILL PRODUCE OXYGEN ENRICHED ATMOSPHERE"



Symbol for "SINGLE USE"
(Applies to Cannula only)



Symbol for "Warning, low temperature / freezing conditions"



Symbol for "Warning: High pressure oxidizing gas vigorously accelerates combustion"

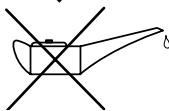

Symbol for "USE NO OIL"

CE 0197

Symbol indicates the device complies with the requirements of Directive 93/42/EEC concerning medical devices and all applicable International Standards. **(On CE marked Devices ONLY)**

T 0035

Symbol indicates the pressure vessel complies with the requirements of Directive 99/36/EC concerning transportable pressure equipment. **(On CE marked Devices ONLY)**

INTENDED USE

To be used as a portable, supplemental, refillable oxygen device which delivers USP (United States Pharmacopeia) Oxygen at a number of various pulsed settings. The device is to be used by patients who may have difficulty extracting oxygen from the atmosphere. It is for patients who would normally receive oxygen via nasal cannula. It is intended to be used as an ambulatory source of Oxygen.

⚠ DANGER

This product is not intended as a life-sustaining or life-supporting device.

SPECIFICATIONS

Dimensions: (Are approximate and may vary by Model)

Weight:

Empty	2.9 lbs (1.32 kg)
Full	3.6 lbs (1.63 kg)
Full (including all accessories)	4.6 lbs (2.09 kg)

Length: 4.81" (12.2 cm)

Width: 3.63" (9.2 cm)

Height: 8.19" (20.8 cm)

Operating Conditions:

Temperature:	40°F to 110°F (4.4°C to 43.3°C)
Altitude:	Sea Level to 10,000 ft (3048 m)

Storage Conditions:

Temperature:	-10°F to 140°F (-23°C to 60°C)
Humidity:	95% Non condensing

Pulse Setting: 0, 1, 2, 3, 4, LPM Equivalents

Maximum Capacity: 0.32 liters

Maximum Working Pressure: 52.94 PSI (3.65 bar)

Cannula Requirement: Maximum 7 foot long standard or high flow adult single lumen oxygen nasal cannula

Pulse Volume Accuracy: Within $\pm 15\%$ of the nominal bolus value (at each breath rate)

Trigger Method: Inspiratory effort (negative pressure from patient inhalation)

Breathing Frequency: 1 to 30 Breaths Per Minute

Specifications subject to change without prior notice.

▲ WARNING

Oxygen supplied from this device is for supplemental use and is not intended to be life supporting or life sustaining. This device is not intended for use by patients who would suffer immediate, permanent, or serious health consequences as a result of an interruption in the oxygen supply.

NEVER smoke in an area where oxygen is being administered.

NEVER use near any type of flame or flammable/explosive substances, vapors or atmosphere.

DO NOT use oils, greases, lubricants or any combustible materials on or near this product. Wash hands properly prior to usage.

DO NOT touch liquid oxygen or parts that have been in contact with liquid oxygen. Liquid oxygen is extremely cold (-297°F/-183°C). When touched, liquid oxygen, or parts of the equipment that have been carrying liquid oxygen, can freeze skin and body tissue.

TO AVOID INCREASED RISK OF FIRE

- Keep this equipment away from electrical appliances. Use and store Reservoir and Portable units at least five feet from electrical appliances that may cause heat or sparks.
- Keep oxygen equipment away from open flames. Use and store Reservoir and Portable at least five feet away from equipment such as furnaces, water heaters, and stoves that may contain open flames.
- **Keep equipment in a well-ventilated area at all times.** These devices periodically release small amounts of oxygen gas that must be ventilated to prevent buildup. **DO NOT** store liquid oxygen equipment in a closet, car trunk, or other confined area. **DO NOT** place blankets, draperies, or other fabrics over equipment.
- High concentrations of oxygen can cause rapid burning of other substances.

ALWAYS confirm prescribed dose before administering to patient and monitor on a frequent basis.

DO NOT carry the Portable device under your clothing. These devices normally vent oxygen. Wearing a Portable device under clothing may saturate fabrics with oxygen and cause them to burn rapidly if exposed to sparks or flame. It may take several hours for oxygen levels in fabric to return to normal.

ALWAYS keep tubing or oxygen supply line away from path of walking to avoid potential trip or fall.

DO NOT use if dirt or contaminants are present on or around fill connectors on the Portable device or Reservoir.

NO OXYGEN is delivered when the Pulse Selector is at the "0" Setting.

NO OXYGEN is delivered in between settings.

▲WARNING

NEVER attempt to repair or disassemble this device. Disassembling or unauthorized repair of this device could create a hazardous condition or cause equipment failure. If you have problems, questions, or are unsure if equipment is operating properly, call your Equipment Provider.

ALWAYS follow CGA P-2.7 standard, (Guide for the safe storage, handling, and use of Portable Liquid Oxygen Systems in Health Care Facilities).

This device is **NOT** to be used by patients who breathe through their mouths.

DO NOT use while sleeping without consulting your Equipment provider.

DO NOT connect the Portable System to a gas source other than Oxygen. Doing this will cause inhalation of hazardous substances.

The cannula is for single patient use only.

▲CAUTION

Consistent with the recommendations of the medical community on the use of conserving devices, it is recommended that the Portable Liquid Oxygen System be qualified on patients in the situations it will be used (rest, exercise, sleep).

This device is designed to operate with a single lumen, adult, nasal cannula with a maximum length of 7 feet or less.

Only individuals instructed and trained in its use should operate this device.

This device contains magnetic, ferrous material that may affect the results of an MRI.

DO NOT use liquid leak detector to test for leaks.

DO NOT autoclave.

DO NOT gas sterilize.

DO NOT clean with aromatic hydrocarbons.

DO NOT immerse device in any kind of liquid.

Store device in a clean area when not in use.

Only use Precision Medical Inc.'s Liquid System carrying bag.

Avoid dropping the device or placing it in a position where it could fall and become damaged.

DO NOT block the outlet fitting or kink the cannula tubing when the device is in use.

Inspiratory efforts vary from patient to patient. The Portable Liquid Oxygen System may not be able to detect respiratory efforts of all patients.

PRINCIPLES OF OPERATION

The Portable Liquid Oxygen System is designed to store and deliver oxygen while maximizing your freedom of movement. The Portable System is used as a supplemental oxygen source which is filled from a reservoir containing liquid oxygen. The device converts the liquid oxygen to a gas which is then available to the patient when triggered by the inspiratory effort of the patient. The Portable System sensing the inspiratory effort, delivers a bolus of oxygen at the prescribed rate using the various pulse settings. The device should be filled just before use.

PORTABLE SYSTEM DESCRIPTION

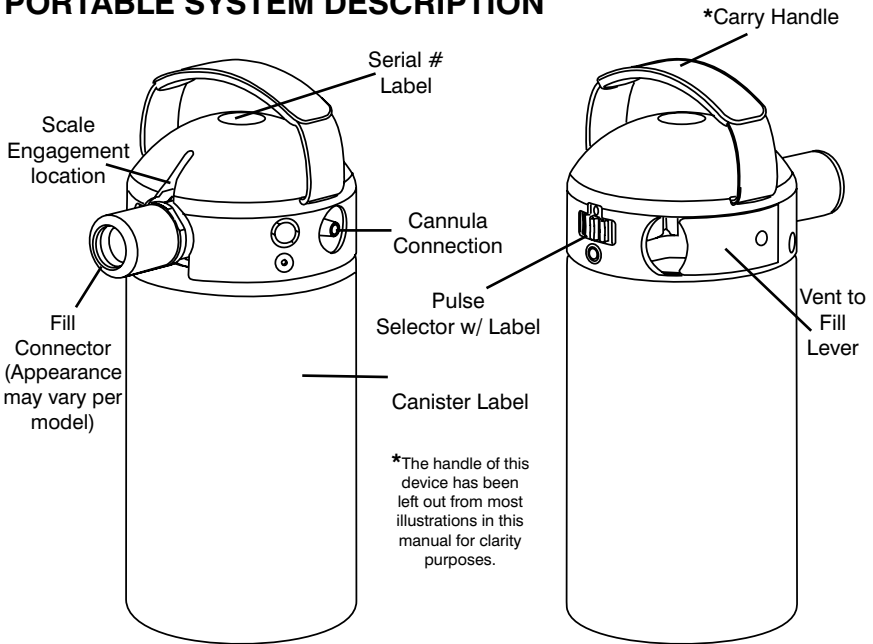

⚠WARNING

Using a clean, dry cloth, wipe the fill connector dry on both the Reservoir and Portable System before filling to prevent freezing.

OPERATING INSTRUCTIONS

Prior to each use. Inspect product for visible damage. **DO NOT** use if any damage is found.

NOTE: If any device labels are missing or illegible contact your Equipment Provider.

OPERATING INSTRUCTIONS continued

Filling the Portable System from the Reservoir

1. Check the contents indicator on the Reservoir to ensure liquid oxygen is available for filling purposes. When the Reservoir is low, inform your Equipment Provider.
2. Remove the cannula from the Device, if attached.
3. Remove the Device from the carrying bag.
4. Remove protective cap on reservoir fill coupler, if applicable.

▲WARNING

DO NOT fill the device while it is in the carrying bag.

The Portable System is intended to be used with any compatible reservoir with a maximum working pressure of 50 PSI (3.45 bar).

5. Using a clean, dry cloth, wipe the fill connector on the Reservoir and Device.
6. Carefully position the Portable , ensuring that the fill connector of the Portable System aligns with the fill connector of the Reservoir.
7. Engagement:

PM2200 (Puritan Bennett, Top Fill):

- Connect the Portable & Reservoir by pressing down to the fill position, being careful not to depress the release button on the Reservoir.
- During filling, maintain a slight downward pressure on the Portable System with one hand to keep the device steady and maintain proper filling position.

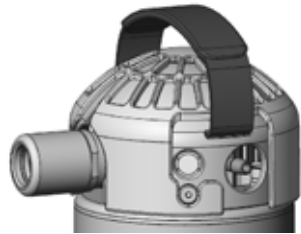

PM2201 (Mark Series, Top Fill with Twist):

- Rotate the Portable System clockwise until the device is locked into position (approximate, rotation 90°) .
DO NOT USE EXCESS FORCE WHEN LOCKING INTO POSITION.

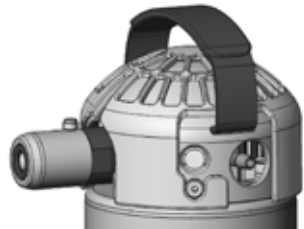

PM2202 (Caire, Side Fill):

- Rotate the Portable System counterclockwise until the pin of the device engages with the slot of the reservoir connector (approximate rotation 45°).
- Carefully and firmly rotate the Portable System back to the upright position, until the Device and Reservoir are locked together.

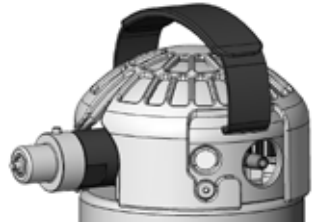

8. While holding the Portable System in the fill position, pull the Vent-to-Fill lever to the open position (**Figure 1**). A hissing noise should be noticeable.

NOTE: PM2200 Top Fill ONLY, maintain a slight downward pressure on the Portable System with one hand to keep the device steady and maintain proper filling position.

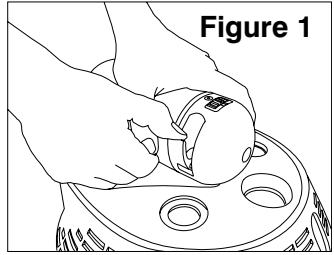

9. Release the Vent-to-Fill lever on the Portable System as soon as you notice a change in the sound of venting gas followed by a dense, white vapor coming from the Reservoir cover.

NOTE: The maximum time to fill a

PM2200 & PM2202	30 seconds.
PM2201	15 seconds.

⚠ CAUTION

If the Vent-to-Fill lever fails to close and the hissing continues, remove the Portable from the Reservoir by depressing the release button on the Reservoir unit. The Portable will stop venting in a few minutes. The Portable may require as much as 30 minutes to restore normal operation.

10. Disengagement:

PM2200:

- Disconnect the Portable System from the Reservoir by pulling in an upright motion. Always hold the device with at least one hand when attempting to disconnect it. (**Figure 2**)

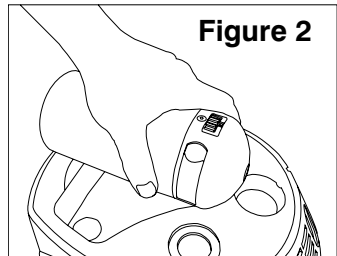

PM2201 / PM2202:

- Disconnect the Portable System from the Reservoir by rotating it in counterclockwise direction until the device separates. The device may now be removed from the Reservoir.

NOTE: 1. It is common to hear a hissing sound after the Portable System has been filled. This is the relief valve venting excess gas pressure. Upon disengaging the Portable System from the Reservoir it is common to see condensation on or near the fill connector.

2. It is common to have a few small droplets of liquid oxygen coming from the fill connector when disengaging the Portable from the reservoir.

CAUTION

DO NOT OVERFILL

Filling device longer than above Max fill times can lead to OVERFILLING. Overfilling does NOT provide any advantages and can cause problems with the use of the device. Overfilling can result in a delay of 30 minutes before the Portable can be used. Releasing the Vent-to-Fill Lever will stop the filling process. Frost on cap of Portable is a sign of overfill.

⚠WARNING

If a liquid oxygen leak occurs at the fill connector when you disconnect the Portable, reconnect and disconnect the Portable System to help dislodge any ice or other obstruction. If the liquid leak persists, notify your oxygen supplier.

If you notice a steady stream of liquid oxygen at the fill connector when you disconnect the Portable System, stay away from the device and immediately notify your oxygen supplier.

DO NOT leave the portable liquid oxygen system unattended during the filling operation.

DO NOT direct flow of oxygen at any person, or flammable material.

NOTE: If the Reservoir and Portable System does not disconnect easily, they may have become frozen. Attempt to disconnect them by depressing the release button on the Reservoir, if applicable. If this does not work **DO NOT USE FORCE**. Simply allow a few minutes for the frozen parts to warm, then disengage the Portable when the ice has melted.

11. Check the approximate oxygen contents in the Portable System using the contents scale.

NOTE: The Portable Liquid Oxygen System will make a hissing noise when venting. This is a normal occurrence.

⚠WARNING

Never open the Vent-to-Fill Lever when Portable System is not connected to Reservoir.

If Vent-to-Fill Lever is inadvertently opened when not connected to Reservoir a burst of cold oxygen will be emitted. It may take as much as 30 minutes to restore to normal operation.

Checking the Approximate Amount of Liquid Oxygen Remaining

1. Remove cannula from Portable System's outlet cannula connection.
2. Remove Portable System from carry bag.
3. Attach the ball end of the contents scale to the Portable System's engagement location (**Figure 3**) by sliding ball into slot above the fill connector.
4. **Hold the content scale with one hand, pull down the Portable will the other hand and release. This method with result in a consistent contents measurement.**
5. Read the contents indicator of the scale to determine the approximate amount of liquid oxygen contents in the device. To ensure you have enough oxygen to meet your needs, check the indicator periodically.
6. **DO NOT** use contents scale for any purpose other than specified, doing so may damage the scale and void the warranty.

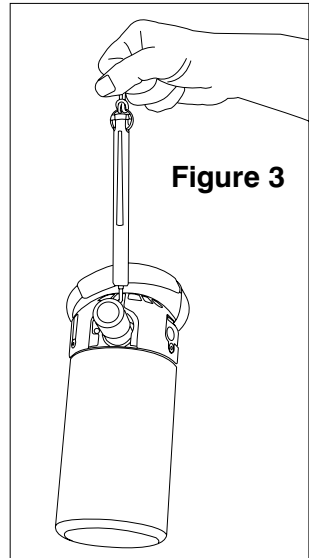

NEVER pull the ball end of the contents scale and allow it to snap back into the scale doing so will damage the scale and void the warranty.

The table below shows approximate use times for the Portable System after it has been completely filled. The table has been constructed using a typical breathing pattern for oxygen patients. **Your use time may vary from the use times listed below.** We recommend that you learn through experience how long the Portable System will last under your circumstances.

Approximate use time of a Full Portable System.	
Pulse Setting	Approximate Use Time
1	9 Hours
2	8 Hours
3	5.3 Hours
4	4.3 Hours

Breathing from the Portable System

1. Attach a **standard adult single lumen oxygen nasal cannula**, (no longer than 7 feet) to the device's cannula connection according to the cannula manufacturer's instructions.

⚠CAUTION
DO NOT use pediatric, low flow nasal cannulas or oxygen masks with this device.

- Align the Pulse Selector to the prescribed setting (**Figure 4**). The **pulse setting value should be clearly visible in the center of the window**.

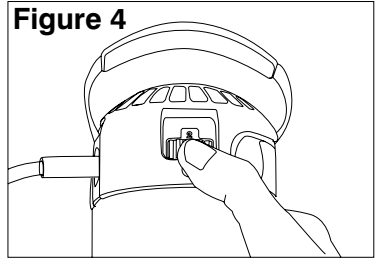

▲WARNING

NO OXYGEN is delivered in between settings.

- Place the cannula in position by inserting the two tips into your nostrils, running the tubing over your ears and then routing the cannula as shown in (**Figure 5**).

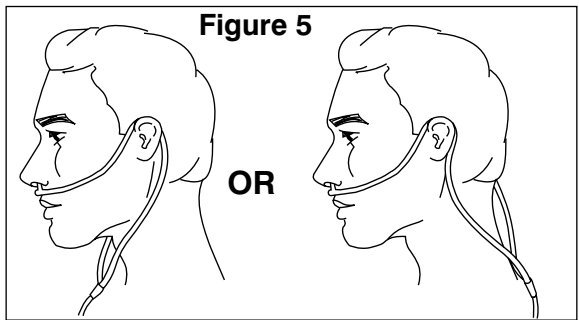

- When your Portable System is set to setting 1 or above, oxygen will be delivered only while you inhale. You should notice a small pulse at the beginning of each breath. Oxygen is delivered during this pulse. It is normal for the device to occasionally skip a breath or to pulse twice in one breath.
- Breathe through the nose and feel a pulse of oxygen as you inhale.
- Insert Portable System into the carry bag.

▲WARNING

Carry bag may become saturated with oxygen which could cause it to burn rapidly if exposed to sparks or flames. It may take several hours for the oxygen levels in fabric to return to normal.

Positioning Device

Always keep the Portable System in an upright position while in use, as illustrated in (Figure 6). Placing the device on its side, or upside down will shorten the usage time device.

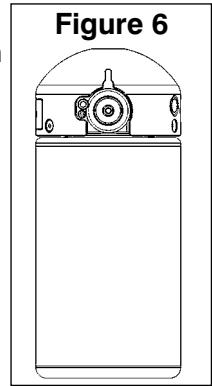

Using the Carry Bag

Figure 7 illustrates how the device should be placed in its bag. Ensure the device is oriented so there are no obstructions to the cannula connection.

The options on how to use the carry bag with the device are illustrated below (Figures 8 -10).

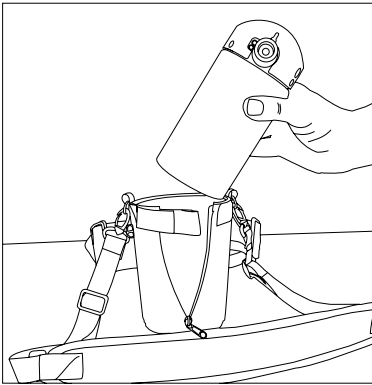

Figure 7

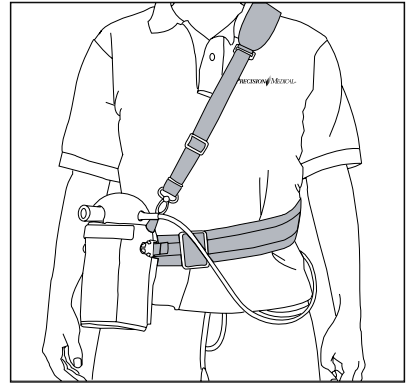

Figure 8

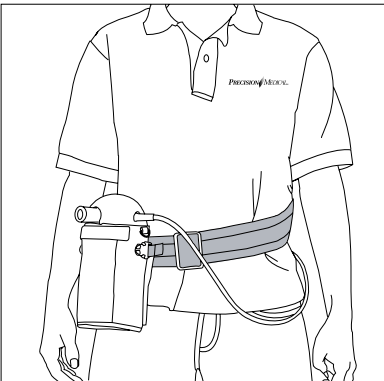

Figure 9

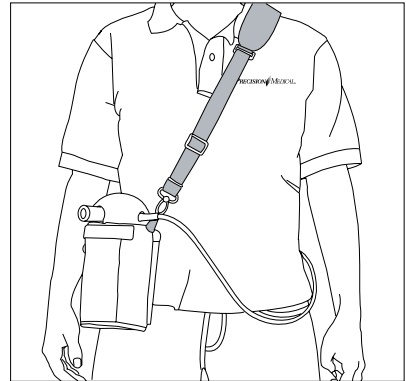

Figure 10

CLEANING

1. As needed, clean exterior of the device with a clean, lint free cloth dampened with water. **Allow device to dry prior to use.**
2. Store device in a clean area free from grease, oil, and other sources of contamination.
3. Replace Carry Bag Liner as needed.

⚠WARNING

DO NOT allow water into any of the controls, or the fill connector.

DO NOT use cleaning solutions.

DO NOT immerse device in any kind of liquid.

DO NOT use alcohol, solvents, polishes, or any oily substance on oxygen equipment.

REPLACEMENT PARTS

Description	Part #
Cannula	504833
Carry Bag Liner	504488
Carry Bag with Liner	504392
Contents Scale	504393

MAINTENANCE

ATTENTION: Equipment Provider

This device contains several field serviceable components. Contact Precision Medical Customer Service to obtain service procedures and related service items.

RETURNS

Returned products require a Returned Goods Authorization (RGA) number. To obtain an (RGA) number, contact Precision Medical, Inc.. All returns must be packaged in sealed containers to prevent damage. The Portable device must be fully depleted of liquid oxygen prior to shipping. Precision Medical, Inc. will not be responsible for goods damaged in transit.

TROUBLESHOOTING

If the Portable Liquid Oxygen System fails to function, consult the Troubleshooting guide.

If problem cannot be corrected, consult your Equipment Provider.

Problem	Probable Cause	Remedy
A. No pulse	<ol style="list-style-type: none"> 1. Device Empty 2. Pulse Selector set to "0" 3. Pulse selector positioned between settings 4. Device not sensing breath 5. Cannula disconnected 6. Kinked or blocked cannula 7. Device overfilled 8. Device not in upright position 	<ol style="list-style-type: none"> 1. Refill device 2. Set to prescribed setting 3. Rotate Pulse selector to your prescribed setting 4. a) Check position of cannula in nose b) Do not breathe through mouth 5. Reconnect cannula 6. Remove kink/obstructions, Replace cannula 7. Wait approximately 30 minutes until device returns to normal operating conditions 8. Position device upright
B. Device not filling	<ol style="list-style-type: none"> 1. Not pulling Vent-to-Fill lever 2. Not connecting fill connectors completely 3. Reservoir empty 	<ol style="list-style-type: none"> 1. Pull out Vent-to-Fill lever 2. Makes sure fill connector are fully engaged 3. Contact Liquid Oxygen Supplier to refill Reservoir

Troubleshooting continued on next page.

Troubleshooting continued:

Problem	Probable Cause	Remedy
C. Unable to disconnect Portable from Reservoir	1. Fill connectors frozen from moisture on fill connectors	1. a) Depress the release button on the Reservoir (PM2200 ONLY) b) Allow time for device to warm
D. Device frosted & no pulse	1. Device overfilled	1. Wait approximately 30 minutes until unit returns to normal operating conditions
E. Device is making a hissing noise, (venting) NOTE: VENTING IS NOT A LEAK!	1. Device was just filled 2. Device was turned on its side 3. Patient is not using device after filled	1. Start using device 2. Hissing should reduce in a few seconds 3. Device will continue to vent until depleted (This is a normal operation)

DISPOSAL

Dispose of the Portable Liquid Oxygen System in accordance with the local regulations.

LIMITED WARRANTY AND LIMITATION OF LIABILITY

Precision Medical, Inc. warrants that the Precision Medical Liquid Oxygen System (the Product) and the following component parts thereof will be free of defects in workmanship and/or material for the following period:

EasyMate Liquid Oxygen System One (1) year from date of shipment

Vacuum Vessel Five (5) years from date of shipment

This limited warranty does not cover: 1) Normal routine service items, 2) Defects due to the wear and tear caused by mating components, 3) Repair or replacement necessitated by misuse, abuse, or accident.

Replacement parts or repaired products shall be free from defects in workmanship and materials for the duration of the unexpired portion of the original warranty or ninety (90) days from the date of reshipment, whichever is longer.

Should any failure to conform to this warranty appear within the applicable period, Precision Medical, Inc. shall, upon written notification thereof and substantiation that the goods have been stored, installed, maintained and operated in accordance with Precision Medical, Inc.'s instructions, operational verification procedures, and standard industry practice, and that no modifications, substitutions, or alterations have been made to the goods, shall, in its discretion, and at its own expense, repair or replace the defective component(s).

ORAL STATEMENTS DO NOT CONSTITUTE WARRANTIES AND THERE ARE NO WARRANTIES OTHER THAN AS SET FORTH IN THIS CONTRACT. Neither the representative of Precision Medical, Inc. nor any retailers are authorized to make oral warranties about the merchandise described in this contract, and any such statements shall not be relied upon and are not part of the contract for sale. This writing is a final, complete and exclusive statement of the terms of the contract and sale.

Precision Medical, Inc. Disclaims any warranty of merchantability, fitness for a particular purpose or any other warranty of quality, whether express or implied except as set forth above.

Precision Medical, Inc. Shall not under any circumstances be liable for special, incidental or consequential damages including but not limited to lost profits, lost sales, or injury to person or property. Correction of non-conformities as provided above shall constitute fulfillment of all liabilities of precision medical, inc. Whether based on contract, negligence, strict tort or otherwise. Precision medical, inc. Reserves the right to discontinue manufacture of any product or change product materials, designs, or specifications without notice.

Precision Medical, Inc. reserves the right to correct clerical or typographical errors without penalty.

DECLARATION OF CONFORMITY

Manufacturer: Precision Medical, Inc.
300 Held Drive, Northampton, PA 18067, USA
CONTACT: Quality Manager
Phone: 610-262-6090

Authorized European Representative: Emergo Europe
Molenstraat 15
2513 BH, The Hague
The Netherlands

Product: Portable Liquid Oxygen System
Model(s): PM2200 Model Series
MDD Class: IIb
Classification criteria: Clause 3.1 Rule 9 of Annex IX of MDD

As delivered, the object of the declaration described above is in conformity with the requirements of MDD 93/42/EEC Annex II.3, 99/36/EC and the following documents:

<u>Document</u>	<u>Title</u>	<u>Edition</u>
94/55/EC Annex A & B	ADR	2005
BS EN ISO 18777	Transportable Liquid Oxygen Systems for Medical Use - Particular Requirements	2005
EN 1251-1	Cryogenic Vessels Part 1 Fundamental Requirements: Marking & Labeling testing.	2000
EN 1251-2	Cryogenic vessels-transportable vacuum insulated vessels of not more than 1000 liters volume-part 2: design, fabrication, inspection and testing	2000
EN 1251-3	Cryogenic vessels-transportable vacuum insulated vessels of not more than 1000 liters volume-part 3: operational requirements	2000
EN 13544-2	Respiratory Therapy Equipment - Part 2: Tubing And Connectors	2002
EN 1418	Welding personnel - approval testing of welding operators for fusion welding and resistance weld setters for fully mechanized and automatic welding of metallic materials	1998
BS EN ISO 15614-1	Specification and qualification of welding procedures for metallic materials - Welding procedure test. Part 1	2004
93/42/EEC	Council Directive Concerning Medical Devices	1993
ISO 18779	Medical Devices for Conserving Oxygen and Oxygen Mixtures - Particular Requirements	2005
EN 14971	Medical Devices - Application of Risk Management to Medical Devices	2000
EN 980	Graphical Symbols for Use in the Labeling of Medical Devices	2003
EN 1041	Information supplied by the Manufacturer with Medical Devices	1998
ISO 10993-1	Biological Evaluation of Medical Devices, Part 1	2003
ISO 10993-5	Biological Evaluation of Medical Devices, Part 5	1999
ISO 10993-10	Biological Evaluation of Medical Devices, Part 10	2002

Notified Body for Product Safety: TUV Rheinland Products Safety GmbH CE ⁰¹⁹⁷
Certification Registration No's: HD60002285, SY60008447, 74_500_2415

Notified Body for Pressure Equipment: TUV Rheinland Pressure Equipment GmbH
Certification Registration No's: 01 202 USA/.06 2888 TT ⁰⁰³⁵

There are no limitations on the validity of the declaration of conformity.



ISO 13485 Certified

Precision Medical, Inc.
300 Held Drive
Northampton, PA 18067 USA

Toll Free Tel: 800-272-7285
Toll Free Fax: 800-353-1240
Tel: (+001) 610-262-6090
Fax: (+001) 610-262-6080

Visit us on the Web: www.precisionmedical.com