

# ***BCI 3303 Oximeter***

## ***Home Use Instruction Book***

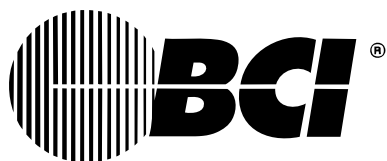

Smiths Medical PM, Inc.  
N7W22025 Johnson Drive.  
Waukesha, WI 53186-1856

---

CATALOG NUMBER 1854  
JUNE 2006 VERSION 3

© 2006 Smiths Medical family of companies. All rights reserved.



## **BCI 3303 Home Use Instruction Book**

### **Chapter 1: How to use the 3303 Oximeter 1-1**

The Monitor's Uses.....	1-1
Visual Clues in this Instruction Book .....	1-1
Definitions.....	1-2
Warnings .....	1-3
Cautions .....	1-4
Notes .....	1-5

### **Chapter 2: What You Need To Have 2-1**

Reference Materials Needed .....	2-1
Equipment and Supplies Needed .....	2-2
Patient Attachments Needed .....	2-3
Other Supplies Needed.....	2-3

### **Chapter 3: Controls and Features 3-1**

Monitor Front Panel.....	3-1
Probe Connector.....	3-1
SpO <sub>2</sub> Numeric Display .....	3-1
Pulse Rate Numeric Display.....	3-2
Pulse Strength Bar Graph.....	3-2
Probe Light.....	3-2
BATT Light.....	3-3
POWER Light.....	3-3
CHGING Light.....	3-3
AC Power Supply.....	3-3
On Key .....	3-4
Off/Stby Key .....	3-4
Ⓜ Silenced Light and Ⓜ Alarm Silence Key .....	3-4
▲ and ▼ Keys.....	3-4
Alarm Sel Key .....	3-4
I.D./Clear Key .....	3-5
Alarm Vol Key .....	3-5
Pulse Vol Key.....	3-5

### **Chapter 4: Checking the Probe & Patient Cable 4-1**

---

**Chapter 5: Attaching the Probe to the Patient 5-1**

Important Information..... 5-1  
#3044 Reusable Probe, Finger ..... 5-3  
#1300 Disposable Probe, Adult #1301 Disposable Probe, Pediatric ..... 5-4  
#1302 Disposable Probe, Neonate ..... 5-6  
#1303 Disposable Probe, Infant..... 5-7

---

**Chapter 6: Monitoring the Patient 6-1**

Turning On the Monitor..... 6-2  
Measuring SpO<sub>2</sub> and Pulse Rate ..... 6-2  
Changing the Brightness of the Display ..... 6-3  
Changing the Pulse Beep Volume ..... 6-3  
Turning Off Alarm and Alert Tones ..... 6-5  
Turning On Alarm and Alert Tones..... 6-5  
Alarms..... 6-6  
Viewing Alarm Limits ..... 6-7  
Alerts..... 6-8  
BATT Attention..... 6-9  
Turning Off the Monitor..... 6-9

---

**Chapter 7: Maintenance 7-1**

Schedule of Maintenance..... 7-1  
Correcting the PROBE Alert ..... 7-3

---

**Chapter 8: Charging the Monitor 8-1**

---

**Chapter 9: Troubleshooting 9-1**

---

**Index Index-1**

## **Chapter 1: How to use the 3303 Oximeter**

This chapter is divided into the following sections:

- The Monitor's Uses
- Visual Clues in this Instruction Book
- Definitions
- Warnings
- Cautions
- Notes

Here are your instructions for installing, using, and taking care of the monitor. Read all instructions carefully. You need this information to use the monitor correctly. Please use pencil when writing in this instruction book. Erase your marks when you return the book so the next person can use it, too.

### **The Monitor's Uses**

The 3303 Monitor is a portable machine that monitors:

- The percent of oxygen absorbed in the blood.
- The pulse rate (how fast the heart is beating).

The monitor has tones and lights to indicate alarms and alerts.

### **Visual Clues in this Instruction Book**

When you see a word printed here in ALL CAPITAL letters, it spells a word that you will see on the front of the monitor.

When you see a word printed here in *italics*, it means that you can find more information on the same subject in another part of this instruction book.

When you see a triangle  it tells you something very important, like this:

 **WARNING! A warning tells you about something that could hurt the patient.**

 **CAUTION! A caution tells you about something that could damage the monitor.**

## Definitions













---

Here are some words you will see in this instruction book. You must understand what they mean.

WORD	DEFINITION
Alarm	Tells you to go immediately to the patient. An alarm will sound when the patient's blood oxygen level or pulse rate requires your attention. The alarm tone sounds like a siren: dee doo, dee doo.
Alert	Tells you to immediately check the monitor to make sure that the patient is being monitored correctly. The alert tone is a single-tone sound with a pause: beep beep, pause, beep beep.
Bar Graph	A series of small lights in a row. The bar graph on the monitor shows the patient's cycle of heart beats.
Caregiver	The person responsible for taking care of the patient. Every caregiver must: <ul style="list-style-type: none"> <li>• Understand all the information in this book.</li> <li>• Always be ready to respond in case of an alarm or alert.</li> <li>• Provide appropriate therapy to the patient when an alarm turns on.</li> <li>• Correct any problem with the monitor when an alert turns on.</li> </ul>
Caution	Tells you about something that could damage the monitor.
AC Power Supply	Provides power to operate the monitor and charge it's battery.
CPR	Cardiopulmonary resuscitation: the procedure used to revive a person whose heart has stopped beating or who is not breathing. Each caregiver must be trained in CPR.
Note	Tells you other important information.
Oxygen	A gas that is normally present in the blood.
Probe	The part of the monitor that is attached to patient.
Pulse Oximeter	The monitor.
Pulse Rate	The number of heart beats that the monitor detects in one minute.
SpO <sub>2</sub>	Saturation of oxygen in the blood determined by a pulse oximeter.
Warning	Tells you about something that could hurt the patient.

## Warnings

---

-  **WARNING!** The monitor does not stimulate the patient or provide therapy to the patient. The monitor only warns the caregiver of a condition. It warns when the patient's blood oxygen level or pulse rate matches or goes beyond the limits set by a doctor. If an alarm turns on, the caregiver must respond with appropriate therapy.
-  **WARNING!** The doctor, or someone appointed by the doctor, must teach each caregiver how to use the monitor and how to respond to alarms.
-  **WARNING!** You must be able to hear the monitor's alarm. Whenever the patient is being monitored, you must be close enough to hear the sound of an alarm or an alert.
-  **WARNING!** Each caregiver must be trained in CPR.
-  **WARNING!** Do not bathe the patient while the patient is connected to the monitor. Remove all attachments from the patient before bathing a patient.
-  **WARNING!** Do not change any of the monitor's settings without a doctor's orders.
-  **WARNING!** Do not sleep in the same bed as the monitored patient.
-  **WARNING!** Keep children and pets away from the monitor and the monitored patient.
-  **WARNING!** Do not place the monitor in the patient's bed or crib. Do not place the monitor on the floor.
-  **WARNING!** Do not use the monitor in an explosive atmosphere.
-  **WARNING!** Failure to place the monitor away from the patient may allow the patient to turn off the monitor, possibly resulting in the patient not being monitored. Make sure the patient cannot reach the monitor from their bed or crib.
-  **WARNING!** Failure to carefully route the cable from the probe to the monitor may allow the patient to become entangled in the cable, possibly resulting in patient strangulation. Route the cable

in a way that will prevent the patient from becoming entangled in the cable. If necessary, use adhesive tape to secure the cable.

 **WARNING!** This device is not intended to be used as an Apnea Monitor.

 **WARNING!** In the event that earth ground integrity is lost, the performance of this device and or other devices nearby may be affected due to excessive RF emissions.

## **Cautions**

---

 **CAUTION!** Do not place the monitor on or near a television set, telephone, air conditioner, humidifier, dehumidifier, or any other electrical appliance. (The monitor may be placed next to a lamp.)

 **CAUTION!** The monitor has a battery that cannot be replaced except by trained persons. Do not attempt to remove or replace the battery. Contact the equipment dealer if there is a problem with the internal battery.

 **CAUTION!** Be sure that the power supply is plugged into an outlet that is grounded. Only an outlet that holds a 3-pronged plug is grounded to reduce the risk of electrical shock.

 **CAUTION!** Do not attempt to stand oximeter upright when not using the protective rubber boot. Position oximeter on back surface.

 **CAUTION!** To clean the monitor or the probe, use only a soft, clean cloth slightly dampened with water or isopropyl alcohol. Do not allow water or any other liquid to be spilled on the monitor or the probe.

 **CAUTION!** Use the monitor only in an area where the temperature is between 32° to 104° F (0° to 40° C) and where the relative humidity is between 20% and 80%.

 **CAUTION!** Failure to charge the monitor while the monitor is not being used may shorten the battery life. Charge the monitor while the monitor is not being used to ensure the longest battery life.

## **Notes**

---

**NOTE!** Federal (USA) law restricts the sale, distribution, or use of this device to, by, or on the order of a physician.

**NOTE!** The monitor may not work properly if the patient's blood flow is restricted. For example, using a blood pressure cuff may restrict the patient's blood flow. Make sure the patient's blood flow is not restricted.



## **Chapter 2: What You Need To Have**

This chapter is divided into the following sections:

- Reference Materials Needed
- Equipment and Supplies Needed
- Patient Attachments Needed
- Other Supplies Needed

### **Reference Materials Needed**

Make sure you have the following:

- A photo copy of the doctor's checklist. The doctor should fill out a checklist with the equipment, supplies, and patient attachments that you will need.
- Written instructions from the doctor telling what to do when you hear the alarm.
- Emergency phone numbers for the doctor, hospital emergency room, and local paramedics or police department in case of a patient emergency.
- Emergency phone numbers for the doctor or the equipment supplier in case the equipment fails.

## ***Equipment and Supplies Needed***

---

As soon as you receive the monitor, make sure you have all of the following:

**Figure 2.1: Equipment and Supplies Needed**

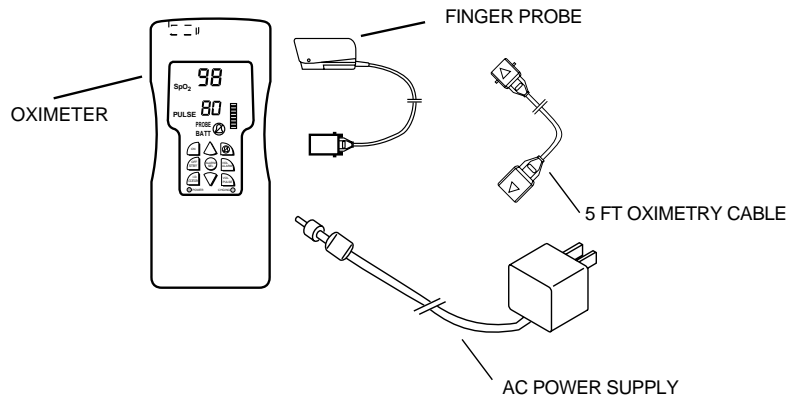

- 3303 Oximeter
- 8210 AC Power Supply
- 3311 Patient Cable
- 3044 Adult Finger Probe

## Patient Attachments Needed

---

This is a complete list of the patient attachments that are available for home use. Each home-use need is special; the doctor will decide which of the following patient attachments you will need and how many.

**Figure 2.2: Patient Attachments Needed**

#3044 PROBE, REUSABLE, FINGER

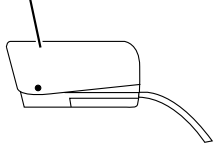

#1300 PROBE, DISPOSABLE, ADULT

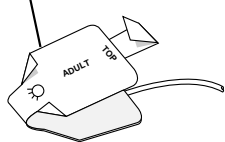

#1301 PROBE, DISPOSABLE, PEDIATRIC

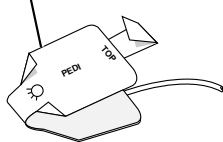

#1302 PROBE, DISPOSABLE, NEONATE

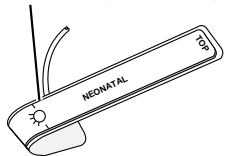

#1303 PROBE, DISPOSABLE, INFANT

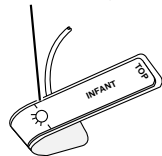

- 3044 Probe, Reusable, Finger
- 1300 Probe, Disposable, Adult
- 1301 Probe, Disposable, Pediatric
- 1302 Probe, Disposable, Neonate
- 1303 Probe, Disposable, Infant

## Other Supplies Needed

---

- Scissors for trimming adhesive tape
- Isopropyl alcohol and a soft, clean cloth (or alcohol wipes) for disinfecting monitor and reusable probe



## Chapter 3: Controls and Features

---

This chapter is divided into the following sections:

- Monitor Front Panel

### Monitor Front Panel

---

**Figure 3.1: Monitor Front Panel**

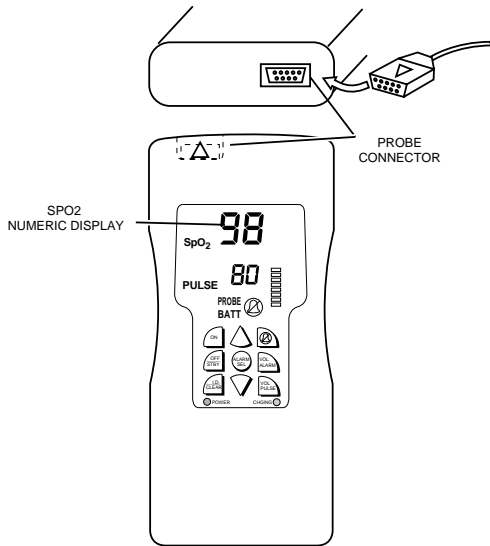

#### Probe Connector

The probe connects here.

#### SpO<sub>2</sub> Numeric Display

A number shows the patient's SpO<sub>2</sub> value in percent. Dashes (---) mean the monitor is not able to figure the SpO<sub>2</sub> value. (See *Troubleshooting* section if dashes are shown.)

Figure 3.2: Monitor Front Panel

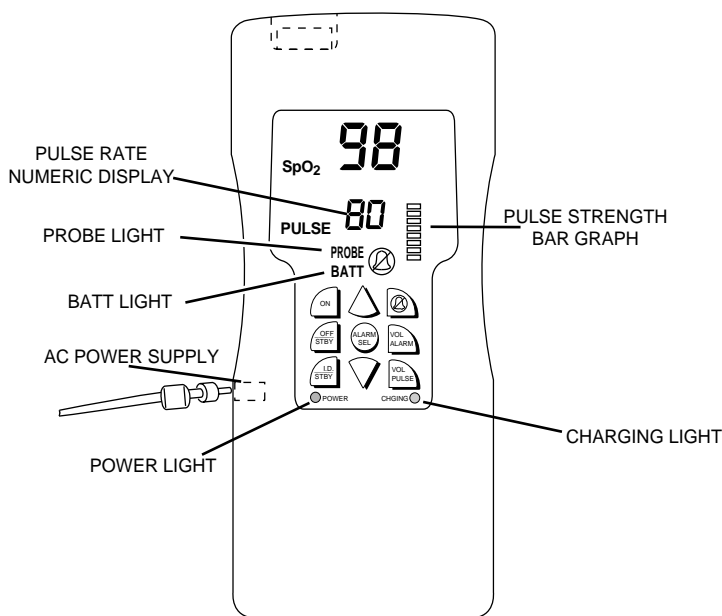

### Pulse Rate Numeric Display

A number shows the patient’s pulse rate value in beats per minute. Dashes (---) mean the oximeter is not able to figure the pulse rate value. (See *Troubleshooting* section if dashes are shown.)

### Pulse Strength Bar Graph

The pulse strength bar graph “sweeps” with the patient’s pulse beat. The height of the bar graph tells the strength of the patient’s pulse.

### Probe Light

PROBE flashes on and off when the probe is not connected to the monitor, the probe is not attached to the patient, or the probe is not properly attached to the patient.

**⚠ WARNING! While PROBE is flashing, the monitor cannot measure the patient’s SpO<sub>2</sub> or pulse rate. You must immediately check the patient’s condition and provide therapy to the patient if necessary. After you have checked the patient’s condition, you must correct the PROBE alert.**

### **BATT Light**

BATT flashes on and off when about one hour of battery use remains. The monitor will work until the battery becomes very weak. When the battery becomes very weak, the monitor will turn itself off.



**WARNING! When BATT flashes, you must immediately charge the monitor's battery. Otherwise, the monitor turns itself off about 30 minutes after BATT begins to flash.**

### **POWER Light**

The POWER light is green when the power supply is attached.

### **CHGING Light**

The CHGING light is yellow when the battery is fast charging.

### **AC Power Supply**

AC power supply connects here.

Figure 3.3: Monitor Front Panel

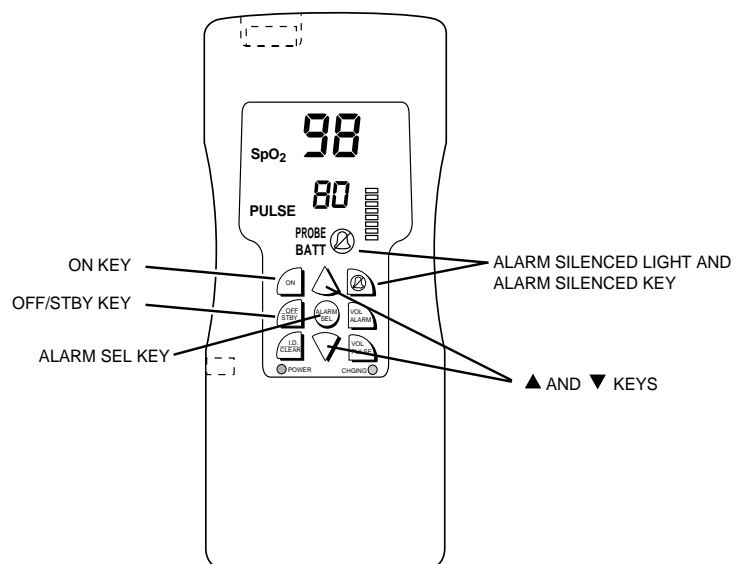

### **On Key**

Pressing ON turns on the monitor.

### **Off/Stby Key**

Pressing OFF/STBY turns off the monitor.

### **ⓧ Silenced Light and ⓧ Alarm Silence Key**

The silenced light flashes on and off when the sound of the alarm is off for two (2) minutes. The silenced light remains off when the sound of the alarm is on.

When the sound of the alarm is on, press the alarm silence key to turn off the sound of the alarm for two (2) minutes. When the sound of the alarm is off, press the alarm silence key to turn on the sound of the alarm.

### **▲ and ▼ Keys**

Pressing ▲ increases the brightness of the SpO<sub>2</sub> and pulse rate displays.

Pressing ▼ decreases the brightness of the SpO<sub>2</sub> and pulse rate displays.

### **Alarm Sel Key**

Pressing ALARM SEL shows each of the alarm limits one-at-a-time.

Figure 3.4: Monitor Front Panel

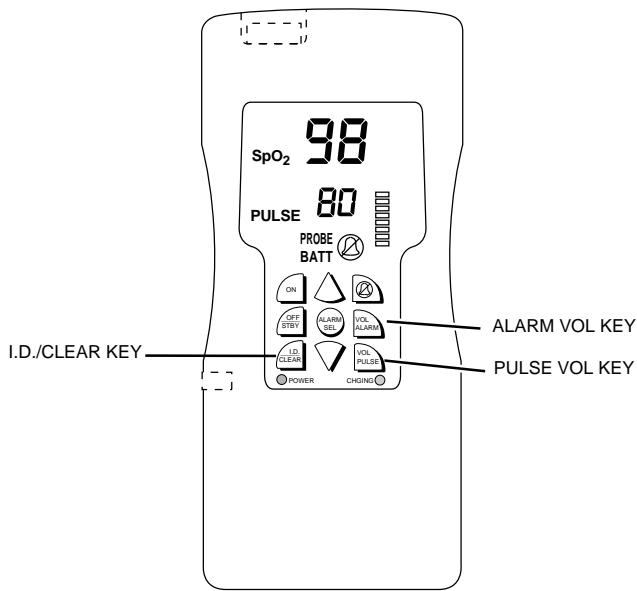
**I.D./Clear Key**

Not used. This key does not affect the monitor.

**Alarm Vol Key**

Not used. This key does not affect the monitor.

**Pulse Vol Key**

Pressing the PULSE VOL key changes the pulse “beep” volume.

**NOTE!** The pulse volume is stored after the monitor is turned off.



## **Chapter 4: Checking the Probe & Patient Cable**

Follow these instructions each time before you attach the probe to the patient. This helps ensure the probe and patient cable are working properly.

**⚠ WARNING! Using a damaged probe may cause inaccurate readings. Inspect each probe. If a probe appears damaged, do not use it. Use another probe or contact the equipment dealer for help.**

1. Carefully inspect the probe to make sure it does not appear damaged.

**⚠ WARNING! Using a damaged patient cable may cause inaccurate readings. Inspect the patient cable. If the patient cable appears damaged, do not use it. Contact equipment dealer for help.**

2. Carefully inspect the patient cable to make sure it does not appear damaged.

**Figure 4.1: Attaching The Probe To The Monitor**

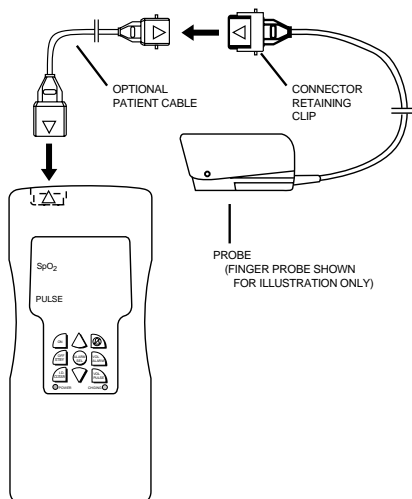

3. If the probe is not already connected to the patient cable, connect the probe to the patient cable as shown above. Push the connectors together firmly and close the clip to secure the connectors.
4. If the patient cable is not already connected to the monitor, connect the patient cable to the monitor as shown above. Push the connector firmly into the monitor.

**Figure 4.2: Turning On The Monitor**

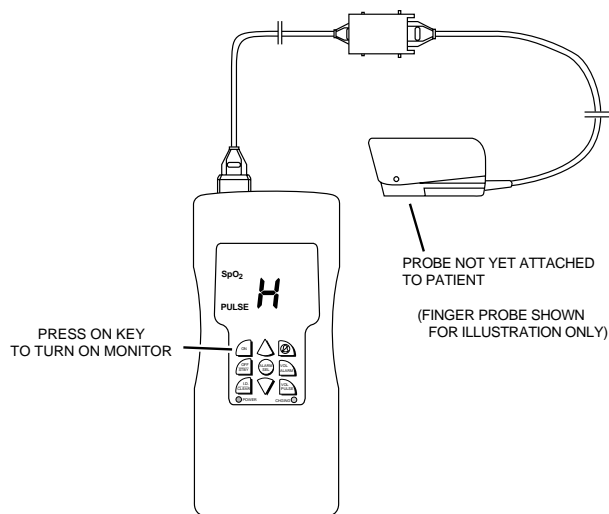

5. If the monitor is not already on, press the ON key to turn on the monitor. An “H” should be shown in the display as the monitor turns on.

**Figure 4.3: Checking Integrity of Probe, Patient Cable, and Oximeter**

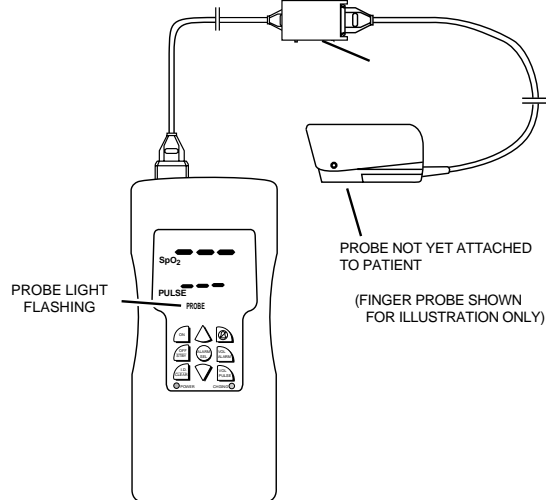

**⚠ WARNING!** If any of the integrity checks fail, do not attempt to monitor the patient. Use another probe or patient cable, or contact the equipment dealer for help if necessary.

6. Before the probe is attached to the patient, check the integrity of the probe, patient cable, and oximeter as follows:
  - a. Make sure the red light in the probe is lit.
  - b. Make sure the PROBE indicator is flashing as follows:

**NOTE! Obstructions or dirt on the probe's red light or detector may cause the checks to fail. Make sure there are no obstructions and the probe is clean.**

- For the finger probe: Make sure the PROBE indicator is flashing on the oximeter.
  - For the disposable probes: Align the probe's red light with the detector so they are less than 1/8 inch away from each other. Make sure the PROBE indicator is flashing on the oximeter.
7. You are now ready to attach the probe to the patient.



## **Chapter 5: Attaching the Probe to the Patient**

This chapter is divided into the following sections:

- Important Information
- #3044 Reusable Probe, Finger
- #1300 Disposable Probe, Adult  
#1301 Disposable Probe, Pediatric
- #1302 Disposable Probe, Neonate
- #1303 Disposable Probe, Infant

### **Important Information**

**⚠ WARNING! Misuse or improper handling of the probe and cable could result in damaging of the probe. This may cause inaccurate readings.**

Hold the connector rather than the cable when connecting or disconnecting the probe to the oximeter as shown.

**Figure 5.1: Disconnecting or connecting the probe.**

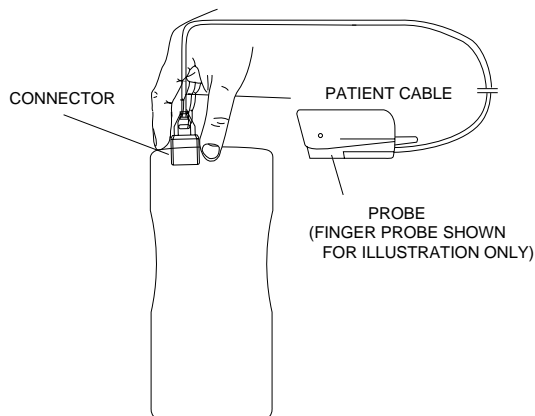

Do not use excessive force, unnecessary twisting, or kinking when connecting, disconnecting, storing, or when using the probe.

Upon completion of patient monitoring, detach the probe as shown in figure 5.1 and loosely coil finger probe cable. Do **not** wrap the probe cable around the oximeter.

When placing the probe on the patient, allow the cable to lay across the palm of the hand and parallel to the arm of the patient as shown.

**Figure 5.2: Positioning the cable of the probe.**

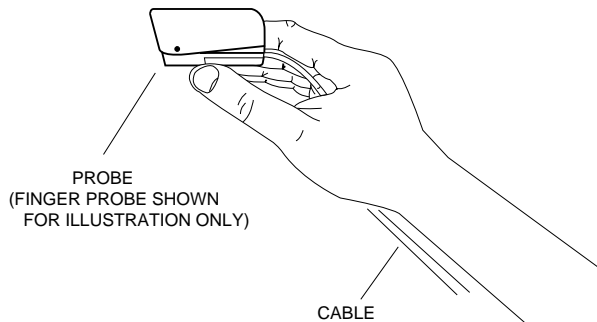

- ⚠ WARNING!** Failure to carefully route the cable from the probe to the monitor may allow the patient to become entangled in the cable, possibly resulting in patient strangulation. Route the cable in a way that will prevent the patient from becoming entangled in the cable. If necessary, use adhesive tape to secure the cable.
- ⚠ WARNING!** Failure to place the monitor away from the patient may allow the patient to turn off the monitor, possibly resulting in the patient not being monitored. Make sure the patient cannot reach the monitor from his/her bed or crib.
- ⚠ WARNING!** At least once every 4 hours, remove the reusable probe and attach it to a different finger on the patient. At least once every 8 hours, remove the disposable probe and attach it to a different place on the patient. This allows the patient's skin to breathe.
- ⚠ WARNING!** When using adhesive tape, do not stretch or apply the tape too tightly. This may cause unreliable readings or blisters on the patient's skin.

Disposable probes can be removed then attached again to the same patient as long as the adhesive secures the probe properly. See Chapter 5 for proper application.

**NOTE!** If the patient has long fingernails, trim them before attaching the probe. Long fingernails may cause unreliable monitor readings because of the inability to properly position the sensor on the patient.

**NOTE!** If the patient has fingernail polish or false fingernails, remove them before attaching the probe. Fingernail polish or false fingernails may cause unreliable readings.

Use adhesive strips to tape the cable to the patient's wrist or ankle. This helps keep the probe in place.

The following illustrations show how to attach all of the probes. Find the probe recommended by the doctor and follow the instructions.

### **#3044 Reusable Probe, Finger**

---

1. Moisten a soft, clean, cotton cloth with isopropyl alcohol.
2. Wipe the inside of the finger probe with the cloth.

**Figure 5.3: Attaching #3044 Reusable Probe, Finger**

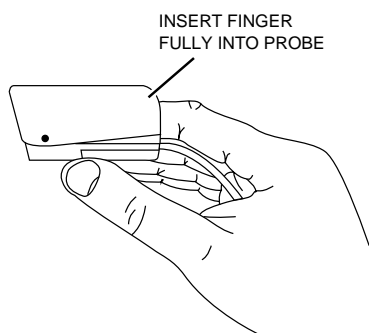

3. Insert one of the patient's fingers into the probe as shown. Be sure to insert the patient's finger into the probe as far as it will go.

**⚠ WARNING!** At least once every 4 hours, remove the probe and attach it to a different finger. This allows the patient's skin to breathe.

**⚠ WARNING!** Do not apply the adhesive tape too tight as to restrict blood flow. Apply the adhesive tape loosely but securely.

**#1300 Disposable Probe, Adult**  
**#1301 Disposable Probe, Pediatric**

---

**Figure 5.4: Attaching #1300 And #1301 Disposable Probes**

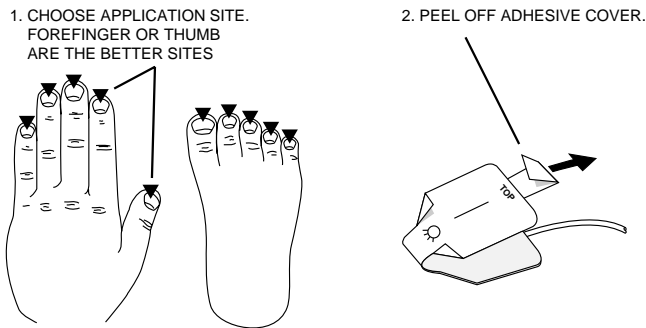

1. Choose an application site on the patient's finger or toe. The forefinger or thumb are the better sites.
2. Grip the tab on the probe's adhesive cover and peel it off.

**Figure 5.5: Attaching #1300 And 1301 Disposable Probes**

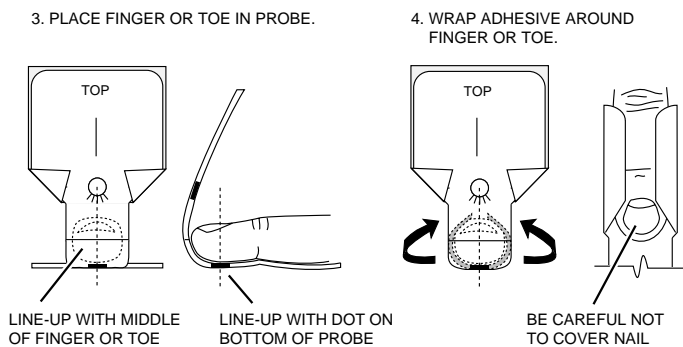

3. Place the patient's finger or toe in the probe nail-side up. Line-up the pad of the finger or toe over the dot on the bottom of the probe. The line in the middle of the probe should run across the middle of the finger or toe.
4. Wrap the adhesive around the finger or toe, being careful not to cover the nail.

**Figure 5.6: Attaching #1300 And 1301 Disposable Probes**

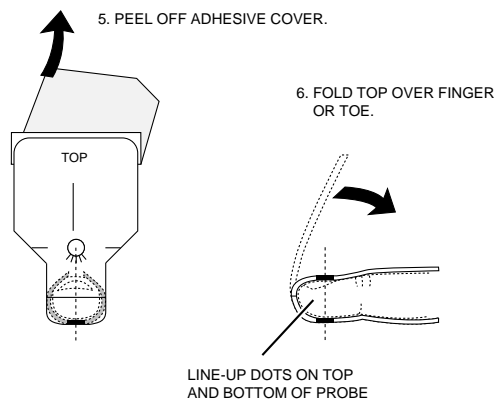

5. Grip the adhesive cover on the top of the probe and peel it off.
6. Fold the top cover of the probe over the finger or toe. Make sure the dot on the top of the probe is directly over and in-line with the dot on the bottom of the probe.

**Figure 5.7: Attaching #1300 And 1301 Disposable Probes**

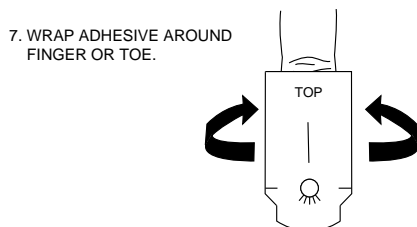

7. Wrap the adhesive around the finger or toe to secure the probe.
8. Route the cable along the palm of the hand or along the bottom of the foot. Secure the cable with a strip of adhesive tape. This helps keep the probe in place.

**WARNING!** At least once every 8 hours, remove the probe and attach it to a different place on the patient. This allows the patient's skin to breathe.

**WARNING!** Do not apply the adhesive tape too tight as to restrict blood flow. Apply the adhesive tape loosely but securely.

## #1302 Disposable Probe, Neonate

**Figure 5.8: Attaching #1302 Disposable Probe**

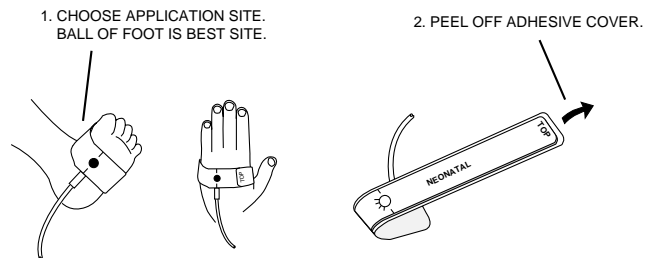

1. Choose an application site on the patient's foot or hand. The ball of the foot is the best side. If you cannot use the ball of the foot, the heel of the hand can be used.
2. Grip the probe's adhesive cover and peel it off.

**Figure 5.9: Attaching #1302 Disposable Probe**

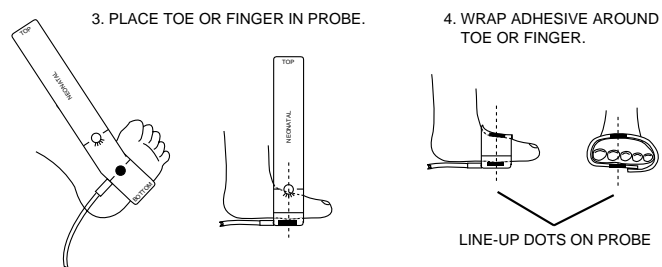

3. Place the patient's sole of the foot or heel of the hand in the probe. Line-up the dot on the top of the probe with the dot on the bottom of the probe.
4. Wrap the adhesive around the foot or hand. Make sure the dot on the top of the probe is directly over and in-line with the dot on the bottom of the probe.
5. Route the cable along the bottom of the foot or along the palm of the hand. Secure the cable with a strip of adhesive tape. This helps keep the probe in place.

**⚠ WARNING! At least once every 8 hours, remove the probe and attach it to a different place on the patient. This allows the patient's skin to breathe.**

**⚠ WARNING! Do not apply the adhesive tape too tight as to restrict blood flow. Apply the adhesive tape loosely but securely.**

### #1303 Disposable Probe, Infant

**Figure 5.10: Attaching #1303 Disposable Probe**

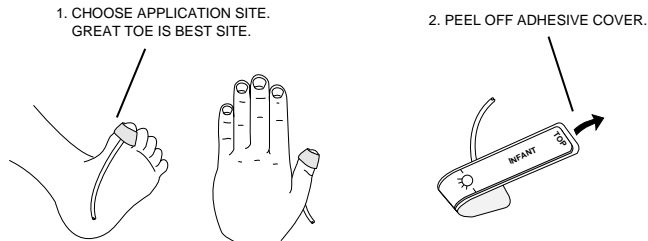

1. Choose an application site on the patient's foot or hand. The great toe is the best side. If you cannot use the great toe, the thumb or another large finger or toe can be used.
2. Grip the probe's adhesive cover and peel it off.

**Figure 5.11: Attaching #1303 Disposable Probe**

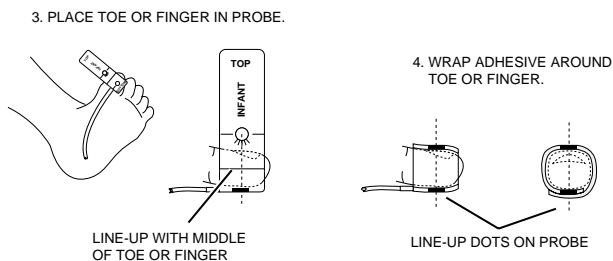

3. Place the patient's toe or finger in the probe nail-side up. Line-up the pad of the toe or finger over the dot on the bottom of the probe. The line in the middle of the probe should run across the middle of the toe or finger.
4. Wrap the adhesive around the toe or finger. Make sure the dot on the top of the probe is directly over and in-line with the dot on the bottom of the probe.
5. Route the cable along the bottom of the foot or along the palm of the hand. Secure the cable with a strip of adhesive tape. This helps keep the probe in place.



**WARNING!** At least once every 8 hours, remove the probe and attach it to a different place on the patient. This allows the patient's skin to breathe.



**WARNING!** Do not apply the adhesive tape too tight as to restrict blood flow. Apply the adhesive tape loosely but securely.

## **Chapter 6: Monitoring the Patient**

Make sure you followed the instructions in the previous sections, *Checking the Probe and Patient Cable* and *Attaching the Probe to the Patient*. You are now ready to monitor the patient's SpO<sub>2</sub> and pulse rate and attend to the monitor's alarms and alerts.

This chapter is divided into the following sections:

- Turning On the Monitor
- Measuring SpO<sub>2</sub> and Pulse Rate
- Changing the Pulse Beep Volume
- Turning Off Alarm and Alert Tones
- Turning On Alarm and Alert Tones
- Alarms
- Viewing Alarm Limits
- Alerts
- BATT Attention
- Turning Off the Monitor

## Turning On the Monitor

Figure 6.1: Turning On The Monitor

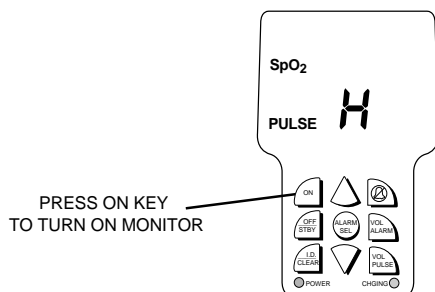

- Press the ON key to turn on the monitor. An “H” is shown in the display as the monitor turns on.

## Measuring SpO<sub>2</sub> and Pulse Rate

Figure 6.2: SpO<sub>2</sub> And Pulse Rate

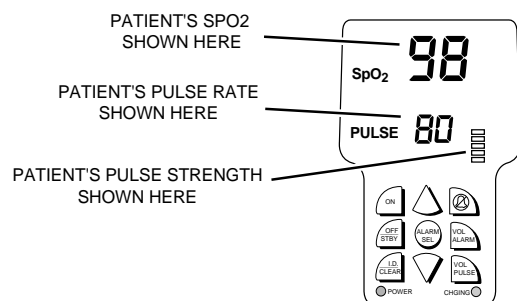

1. Several seconds after turning on the monitor, the patient’s SpO<sub>2</sub> measurement should be shown. If not, see *Troubleshooting* section for help.
2. Several seconds after turning on the monitor, the patient’s pulse rate measurement should be shown. If not, see *Troubleshooting* section for help.
3. Several seconds after turning on the monitor, the patient’s pulse strength should be shown. If not, see *Troubleshooting* section for help.

## Changing the Brightness of the Display

**⚠ WARNING!** Adjusting the display too dim may cause the display to be difficult to read in bright light. Make sure the display is bright enough to be seen under all light conditions.

- Use the ▲ or ▼ keys to change the brightness of the display:
  - To increase the brightness of the display, press the ▲ key.
  - To decrease the brightness of the display, press the ▼ key.

## Changing the Pulse Beep Volume

A “beep” tone sounds with each pulse beat. The volume can be soft, loud, or off.

**Figure 6.3: Changing The Pulse Beep Volume**

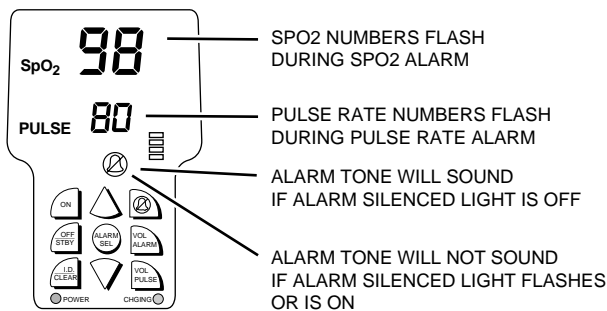

1. If the pulse “beep” tone is sounding, change the volume as follows:

PULSE VOL KEY PRESS	RESULT
First press.	Pulse “beep” tone off.
Second press.	Pulse “beep” tone soft.
Third press.	Pulse “beep” tone loud.
Subsequent presses.	Pulse “beep” tone cycles through off, soft, and loud.

2. If the pulse “beep” tone is off, change the volume as follows:

<b>PULSE VOL KEY PRESS</b>	<b>RESULT</b>
First press.	Pulse “beep” tone soft.
Second press.	Pulse “beep” tone loud.
Third press.	Pulse “beep” tone off.
Subsequent presses.	Pulse “beep” tone cycles through soft, loud, and off.

## Turning Off Alarm and Alert Tones

When the silenced light  is not flashing but remains off, the alarm and alert tones sound whenever an alarm or alert turns on.

**Figure 6.4: Turning Off Alarm And Alert Tones**

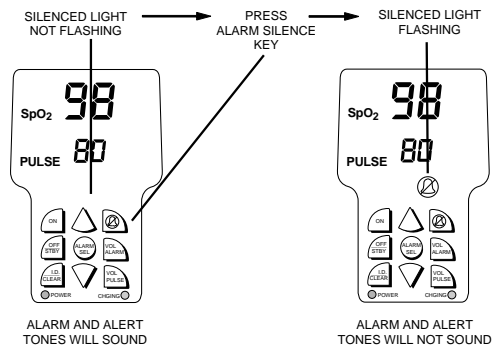



- To turn off alarm and alert tones for two minutes, press the alarm silence key  so the silenced light flashes.

## Turning On Alarm and Alert Tones

When the silenced light  is flashing, the alarm and alert tones will not sound if an alarm or alert turns on.

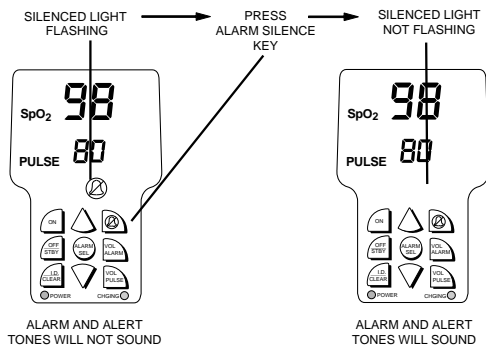
**Figure 6.5: Turning On Alarm And Alert Tones**



- To turn on alarm and alert tones, press the alarm silence key  so the silenced light is not flashing but remains off.

## Alarms

Alarms warn you about an abnormal patient condition.

An alarm turns on when:

- The patient's SpO<sub>2</sub> reading matches or goes beyond the SpO<sub>2</sub> alarm range.

or

- The patient's pulse rate reading matches or goes beyond the pulse rate alarm range.

**Figure 6.6: Alarm Example**

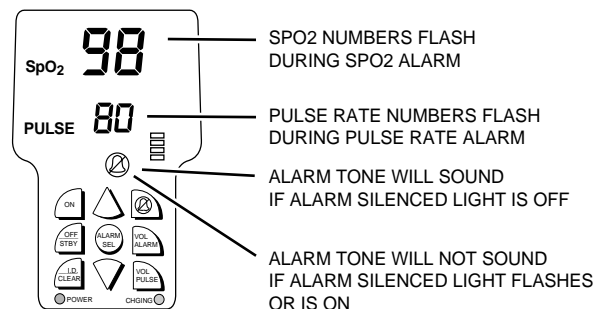

During an alarm:

- The numbers flash that correspond to the alarm.
- The alarm tone sounds, if not silenced. The alarm tone sounds like a siren: dee, doo, dee, doo.



**WARNING!** The monitor only warns the caregiver of a condition. It warns when the patient's SpO<sub>2</sub> or pulse rate reading matches or goes beyond the limits set by a doctor. The monitor does not stimulate the patient or provide therapy to the patient. If an alarm turns on, the caregiver must respond with appropriate therapy.

**NOTE!** Both the SpO<sub>2</sub> and pulse rate numbers will flash if both readings match or go beyond their alarm range.

## Viewing Alarm Limits

---

You can view, but not change, the settings for the SpO<sub>2</sub> and pulse rate alarms. The alarm limits are ordered by the doctor. They were properly set before you received the monitor.

- To view the alarm limits, press the ALARM SEL key until the desired alarm limit is shown as follows:

ALARM SEL KEY PRESS	DISPLAY	ALARM LIMIT
First press	--- HI	--- = High SpO <sub>2</sub> alarm limit. (Example only.)
Second press	85 Lo	85 = Low SpO <sub>2</sub> alarm limit. (Example only.)
Third press	HI 155	155 = High pulse rate alarm limit. (Example only.)
Fourth press	Lo 50	50 = Low pulse rate alarm limit. (Example only.)
Fifth press	97 74	97 = SpO <sub>2</sub> measurement. (Example only.) 74 = Pulse rate measurement. (Example only.)

**NOTE:** “ --- ” in the display means the limit is set to off.

## Alerts

An alert warns you about an abnormal monitor condition.

An alert turns on when:

- The probe is not connected to the monitor.
- or
- The probe is not attached to the patient.
- or
- The probe is not properly attached to the patient.

**Figure 6.7: Alert Example**

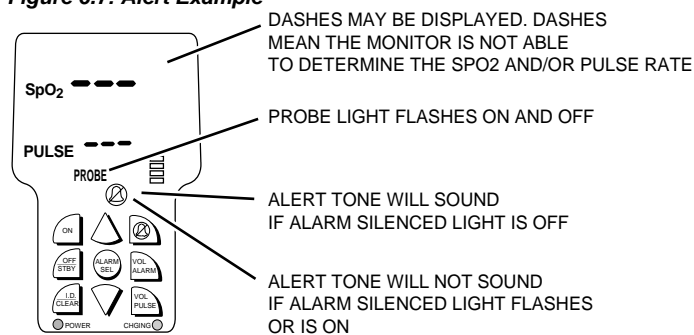

During an alert:

- The PROBE light flashes on and off.
- The alert tone sounds, if not silenced. The alert tone is a single-tone sound with a pause: beep beep, pause, beep beep.



**WARNING!** While PROBE is flashing, the monitor cannot measure the patient's SpO<sub>2</sub> or pulse rate. You must immediately check the patient's condition and provide therapy to the patient if necessary. After you have checked the patient's condition, you must correct the PROBE alert. See *Correcting the PROBE Alert* for help.

## BATT Attention

A BATT attention occurs to tell you the monitor's battery is becoming weak. The BATT attention first occurs when about one hour of battery use remains.

Figure 6.8: BATT Attention Example

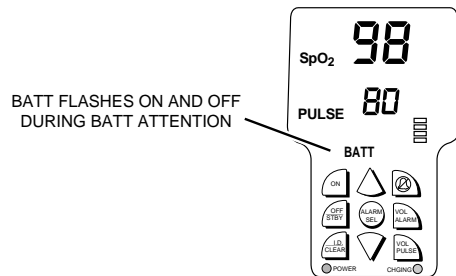

During the BATT attention:

- A short burst of beeps sounds every 30 seconds.
- The BATT light flashes on and off.



**WARNING!** When BATT flashes, you must immediately charge the monitor's battery. Otherwise, the monitor turns itself off about one hour after BATT begins to flash. See *Charging the Monitor* for help.

## Turning Off the Monitor

Turn off the monitor when you are not monitoring a patient.

Figure 6.9: Turning Off The Monitor

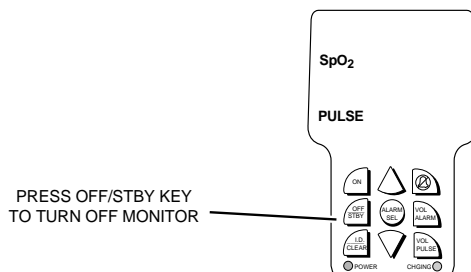

- To turn off the monitor, press the OFF/STBY key.



## **Chapter 7: Maintenance**

---

This chapter is divided into the following sections:

- Schedule of Maintenance
- Correcting the PROBE Alert
- Correcting the BATT Attention

### **Schedule of Maintenance**

---

<b>MAINTAIN THIS ITEM:</b>	<b>HOW OFTEN:</b>	<b>BY DOING THIS:</b>	<b>PAGE:</b>
Battery.	When BATT is flashing, or after the monitor has been used under battery power.	Follow the instructions for charging the monitor.	8-1
Repositioning the probe.	At least once every 24 hours.	Follow the instructions for attaching the patient.	5-1 to 5-7
Repositioning the reusable finger probe.	At least once every 4 hours.	Follow the instructions for attaching the patient.	5-1 to 5-7
Repositioning the disposable probe.	At least once every 8 hours.	Follow the instructions for attaching the patient.	5-1 to 5-7
Disinfecting the #3044 reusable probe.	Before attaching the probe to the patient.	Follow the instructions for attaching the #3044 reusable probe.	5-3

<p>Disinfecting the monitor and the AC power supply.</p>	<p>When necessary.</p>	<ol style="list-style-type: none"><li>1. Remove the monitor from the AC power supply.</li><li>2. Disconnect the AC power cord from the wall outlet and from the monitor.</li><li>3. Wipe the surfaces of the monitor and the AC power supply with a soft, clean cloth dampened in isopropyl alcohol. Use only a cloth that is dampened, not wet.</li></ol> <p> <b>CAUTION! Do not allow isopropyl alcohol to enter any of the openings on the monitor.</b></p>	
--	------------------------	---	--

## ***Correcting the PROBE Alert***

---

Follow these steps to correct the probe alert:

1. Make sure the probe's connector is firmly seated in the monitor's connector.
2. Make sure the probe is properly attached to the patient. See *Attaching the Probe to the Patient* for help.
3. Make sure the adhesive tape used to hold the probe is not wrapped too tightly. Wrapping the tape too tightly may prevent the monitor from measuring the SpO<sub>2</sub> and pulse rate.
4. If the probe alert is still on, contact your doctor or the equipment dealer for help.



## Chapter 8: Charging the Monitor

Figure 8.1: Connecting AC Power.

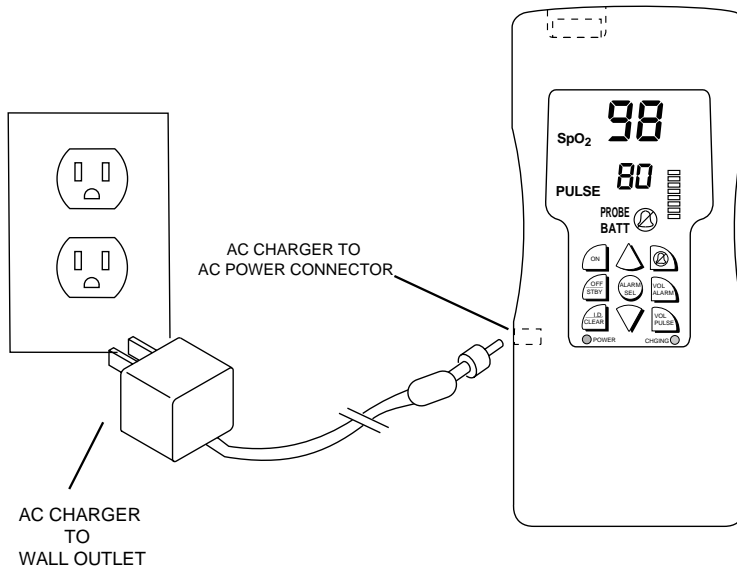

1. Connect the AC charger as shown.
2. Make sure the POWER indicator lights up on the charger. If not, see the *Troubleshooting* section.
3. CHGING indicator lights while the monitor's battery is charging.
4. Device is fully charged when the CHGING light turns off.
5. The monitor's battery will fully charge in about four (4) hours. A fully charged battery provides approximately twelve hours of use.
6. The device may be operated while charging.



## Chapter 9: Troubleshooting

---

PROBLEM:	POSSIBLE CAUSE / SOLUTION:	PAGE:
PROBE alert.	<ol style="list-style-type: none"> <li>1. Probe may not be properly connected to monitor. Make sure probe connector is firmly seated in monitor connector.</li> <li>2. Probe may not be properly attached to patient. See <i>Attaching the Probe to the Patient</i>.</li> <li>3. Adhesive tape may be too tight on patient. Loosen adhesive tape.</li> <li>4. Probe or monitor may be defective. Contact equipment dealer for help.</li> </ol>	<p>5-1 to 5-3</p> <p>5-1 to 5-7</p>
BATT attention.	Monitor's battery has become weak from use. See <i>Charging the Monitor</i> .	8-1
<p>SpO<sub>2</sub>, pulse rate, or pulse bar graph not shown on monitor.</p> <p>or</p> <p>Dashes shown on display.</p>	<ol style="list-style-type: none"> <li>1. Patient may be moving. Have patient remain as still as possible.</li> <li>2. Probe may not be properly connected to monitor. Make sure probe connector is firmly seated in monitor connector.</li> <li>3. Probe may not be properly attached to patient. See <i>Attaching the Probe to the Patient</i>.</li> <li>4. Adhesive tape may be too tight on patient. Loosen adhesive tape.</li> <li>5. Probe or monitor may be defective. Contact equipment dealer for help.</li> </ol>	<p>5-1 to 5-3</p> <p>5-1 to 5-7</p>
Monitor does not turn on when ON key is pressed.	<ol style="list-style-type: none"> <li>1. Battery needs charging. See <i>Charging the Monitor</i>.</li> <li>2. Monitor may be defective. Contact equipment dealer for help.</li> </ol>	8-1
Monitor turns off suddenly.	Battery needs charging. See <i>Charging the Monitor</i> .	8-1

PROBLEM:	POSSIBLE CAUSE / SOLUTION:	PAGE:
POWER does not light when AC power is attached.	<ol style="list-style-type: none"><li>1. Make sure the AC power supply is firmly connected to the wall outlet and to the monitor.</li><li>2. Make sure the wall outlet is not controlled by a switch.</li><li>3. Make sure AC power is available at the wall outlet. (Plug a lamp or a radio into the same wall outlet and see if the lamp or radio turns on.)</li><li>4. AC power supply or monitor may be defective. Contact equipment dealer for help.</li></ol>	8-1
CHGING does not light on the monitor.	Monitor's battery may be charged.	8-1

# Index

---

ⓧ Silenced Light and ⓧ Alarm Silence Key.....	3-4
#1300 Disposable Probe, Adult .....	5-4
#1301 Disposable Probe, Pediatric .....	5-4
#1302 Disposable Probe, Neonate .....	5-6
#1303 Disposable Probe, Infant .....	5-7
#3044 Reusable Probe, Finger .....	5-3
AC Power Supply.....	3-3
Alarm Sel Key.....	3-4
Alarm Vol Key.....	3-5
Alarms .....	6-6
Alerts.....	6-8
BATT Attention .....	6-9
BATT Light.....	3-3
Cautions .....	1-4
Changing the Brightness of the Display.....	6-3
Changing the Pulse Beep Volume.....	6-3
Chapter 1: How to use the 3303 Oximeter.....	1-1
Chapter 2: What You Need To Have .....	2-1
Chapter 3: Controls and Features.....	3-1
Chapter 4: Checking the Probe & Patient Cable .....	4-1
Chapter 5: Attaching the Probe to the Patient .....	5-1
Chapter 6: Monitoring the Patient.....	6-1
Chapter 7: Maintenance .....	7-1
Chapter 8: Charging the Monitor .....	8-1
Chapter 9: Troubleshooting .....	9-1
CHGING Light .....	3-3
Correcting the PROBE Alert.....	7-2
Definitions.....	1-2
Equipment and Supplies Needed .....	2-2
I.D./Clear Key .....	3-5
Important Information.....	5-1
Measuring SpO <sub>2</sub> and Pulse Rate .....	6-2
Monitor Front Panel.....	3-1
Notes .....	1-5
Off/Stby Key .....	3-4
On Key .....	3-4
Other Supplies Needed.....	2-3
Patient Attachments Needed .....	2-3
POWER Light.....	3-3
Probe Connector.....	3-1
Probe Light.....	3-2
Pulse Rate Numeric Display .....	3-2

*Index*

Pulse Strength Bar Graph .....	3-2
Pulse Vol Key .....	3-5
Reference Materials Needed .....	2-1
▲ and ▼ Keys .....	3-4
Schedule of Maintenance .....	7-1
SpO <sub>2</sub> Numeric Display .....	3-1
The Monitor's Uses .....	1-1
Turning Off Alarm and Alert Tones .....	6-5
Turning Off the Monitor .....	6-9
Turning On Alarm and Alert Tones .....	6-5
Turning On the Monitor .....	6-2
Viewing Alarm Limits .....	6-7
Visual Clues in this Instruction Book .....	1-1
Warnings .....	1-3