

BIVONA[®] CUSTOMIZED FLEXTEND[™] TRACHEOSTOMY TUBE TEMPLATE (USA ONLY)



SELECT TYPE SERVICE

- 3-4 WEEKS (STERILE)
- STANDARD SERVICE (NON STERILE)
- EXPRESS SERVICE (NON STERILE)
- SAME DAY SERVICE (NON-STERILE)

NECK FLANGE OPTIONS.

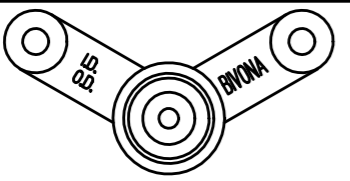
 A

FIXED NECK FLANGE
AVAILABLE SIZES:
2.5 - 5.5mm

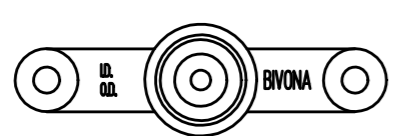
 B

FIXED NECK FLANGE
AVAILABLE SIZES:
2.5 - 9.5mm

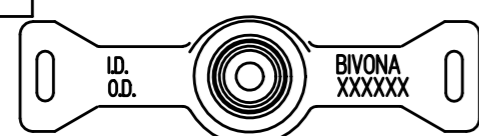
 C

FIXED NECK FLANGE
AVAILABLE SIZES:
2.5 - 9.5mm

 D

FIXED NECK FLANGE
AVAILABLE SIZES:
2.5 - 9.5mm

*"C" SHAFT IS
WIRE REINFORCED ON
ALL OPTIONS.

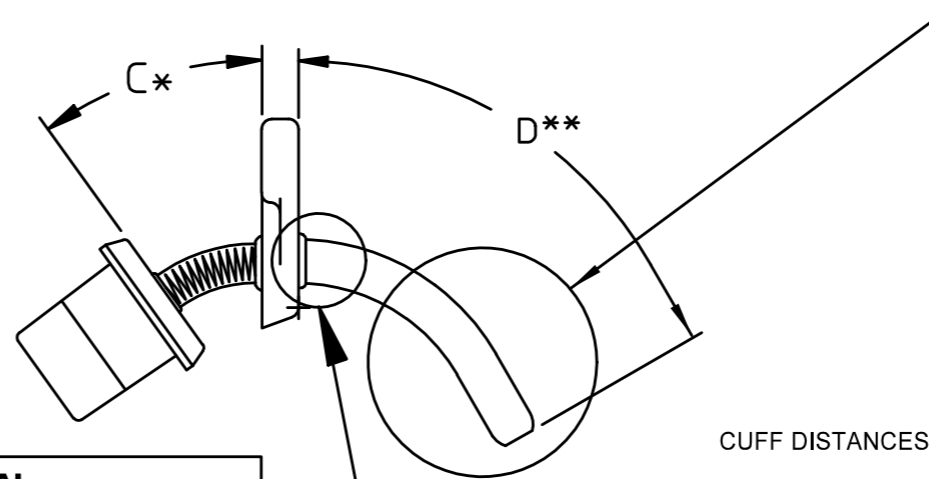

OPTIONAL

- SOLID SILICONE
- FOME-CUF[®]
- AIRE-CUF[®] CUFF POSITION FLUSH (OR) _____mm FROM NECK PLATE.
- TTS[™] CUFF
- TALK ATTACHMENT

CUFF DISTANCES
FROM TIP
_____mm
(OR)
 STANDARD
DISTANCE

"C" SHAFT LENGTH AT
CENTER LINE
_____mm

"D" SHAFT LENGTH AT
CENTER LINE
_____mm

**
SHAFT: I.D. _____mm
(OR) O.D. _____mm

SHAFT OPTIONS: ("D" SHAFT ONLY)

STANDARD SILICONE

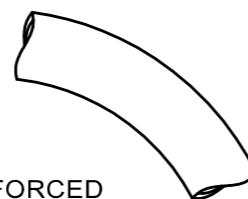

HYPERFLEX[™]

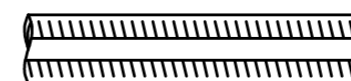

CUFF OPTIONS.

- UNCUFFED
- TTS[™] TIGHT TO SHAFT

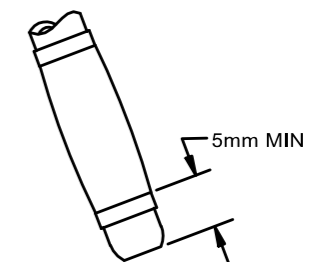

AIRE-CUF[®]

PED. A/C ADULT A/C (MID-RANGE)

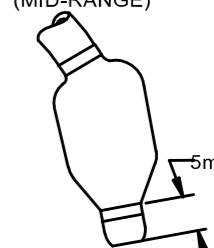

FOME-CUF[®]

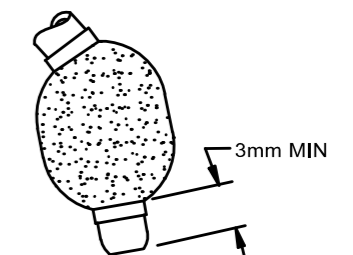

CLINICIAN:

P.O. NUMBER:

FOR QUESTIONS CALL
1-800-424-8662 (USA ONLY)
(001)(219)989 9150 (OUTSIDE USA)

SMITHS-MEDICAL USE ONLY

CLINICIAN SIGNATURE: DATE:

METHOD OF PAYMENT:

APPROVAL:

CLINICIAN CREDENTIALS:

REORDER#

PATIENT/CLIENT ID:

FACILITY TYPE

FAX COMPLETED TEMPLATES TO
(001)(219)989-7435