

# BIVONA<sup>®</sup> CUSTOMIZED ADJUSTABLE NECK FLANGE HYPERFLEX<sup>™</sup> TRACHEOSTOMY TUBE TEMPLATE (USA ONLY)



### SELECT TYPE SERVICE

3-4 WEEKS (STERILE)

STANDARD SERVICE (NON STERILE)

EXPRESS SERVICE (NON STERILE)

SAME DAY SERVICE (NON-STERILE)

### NECK FLANGE OPTIONS.

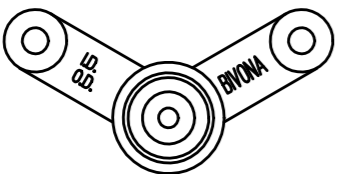
 A

ADJUSTABLE NECK FLANGE  
AVAILABLE SIZES:  
2.5 - 5.5mm

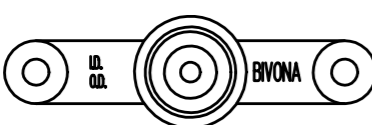
 B

ADJUSTABLE NECK FLANGE  
AVAILABLE SIZES:  
5.0 - 9.5mm

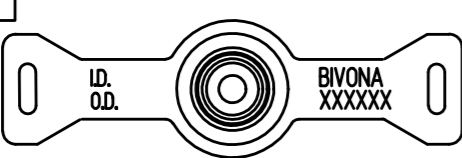
 C

ADJUSTABLE NECK FLANGE  
AVAILABLE SIZES:  
5.0 - 9.5mm

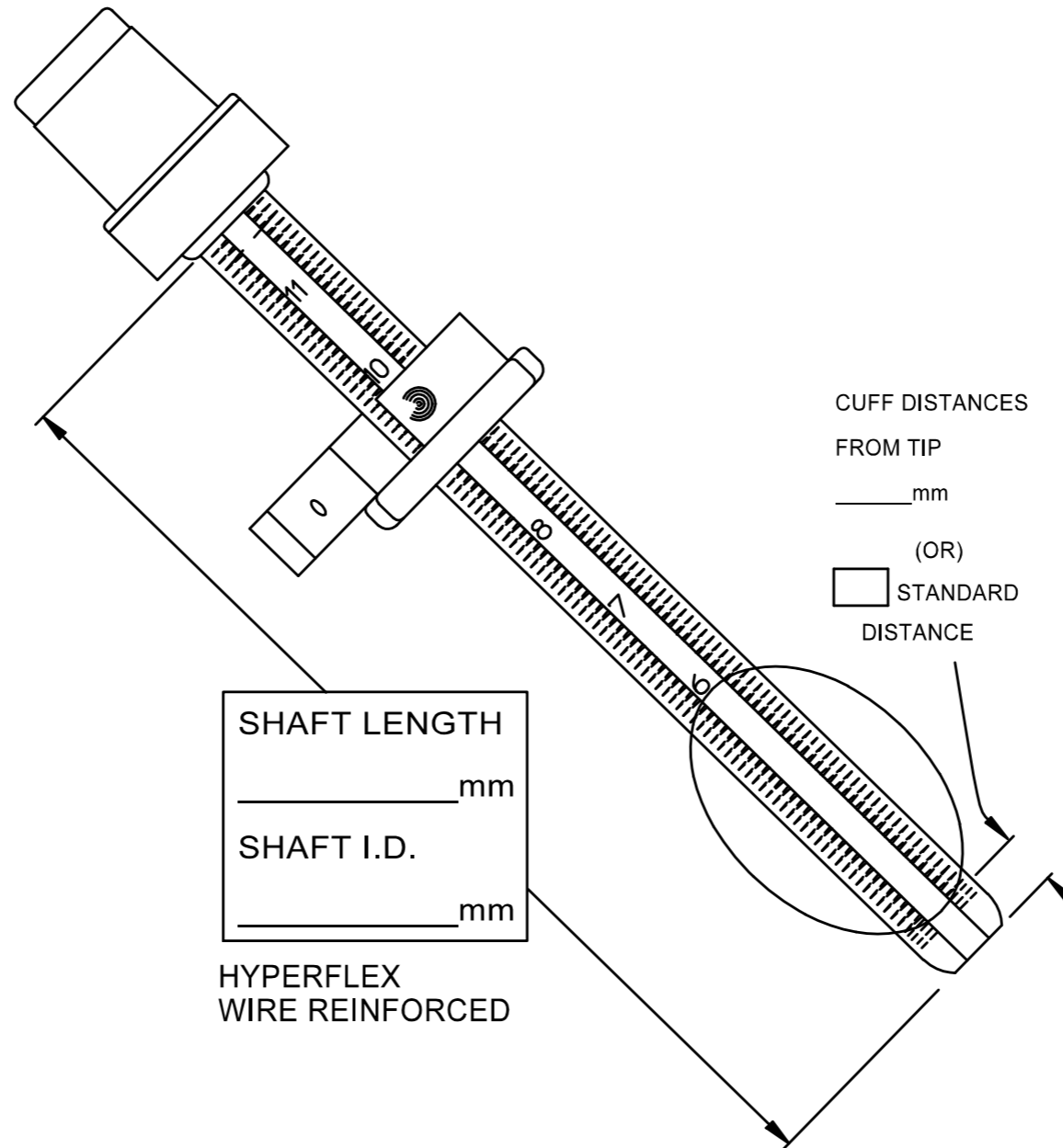

### CUFF OPTIONS.

UNCUFFED

TTS<sup>™</sup> TIGHT TO SHAFT

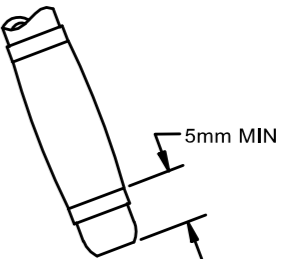

AIRE-CUF<sup>®</sup>

PED. A/C      ADULT A/C (MID-RANGE)

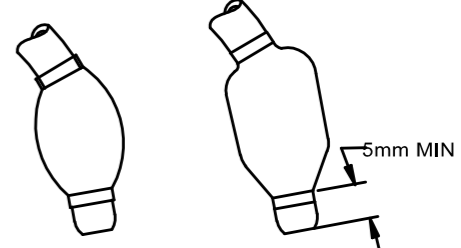

FOME-CUF<sup>®</sup>

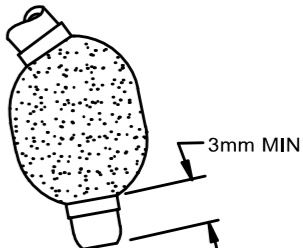

CLINICIAN:	DATE:	P.O. NUMBER:	FOR QUESTIONS CALL 1-800-424-8662 (USA ONLY) (001)(219)989 9150 (OUTSIDE USA)	SMITHS-MEDICAL USE ONLY
CLINICIAN SIGNATURE:		METHOD OF PAYMENT:		APPROVAL:
CLINICIAN CREDENTIALS:			FAX COMPLETED TEMPLATES TO (001)(219)989-7435	REORDER#
PATIENT/CLIENT ID.	FACILITY TYPE			

SOP-04-07 APPENDIX 9 REV 12 PAGE 1 OF 1

(NOT INTENDED FOR LONG TERM USE; FOR TEMPORARY USE ONLY.)

Website: [www.smiths-medical.com](http://www.smiths-medical.com)

CAUTION FEDERAL (USA) LAW RESTRICTS THIS DEVICE TO SALE BY OR ON THE ORDER OF A PHYSICIAN  
NOTE: PLEASE PRINT CLEARLY. SMITHS-MEDICAL WILL REVIEW THE COMPLETED TEMPLATE FOR COMPLIANCE.  
ANY REQUIRED MODIFICATIONS WILL BE MADE WITH THE APPROVAL OF THE CLINICIAN.